

JANUARY 16, 2026



AMMONIUM BICARBONATE FOOD GRADE  
DATA PACKAGE

## Table of Contents

1. Letter to Our Customers
2. General
  - Product
  - Supplier
  - Manufacturer
3. Product Details
  - Product References
  - Storage
  - Compliance
  - Packaging
  - Contaminants
  - Residual
  - BSE/TSE/GMO
  - Composition
4. Manufacturing
  - Site Information
  - Process
  - Manufacturing Information
  - Quality system
  - Lot Numbering System
  - Products Not Used in Manufacturing of Product
5. Food Information
  - Food Information
  - Diet Suitability
  - Microbiological
  - Nutritional Value
6. Documents

## Letter to Our Customers

Dear Valued Customer,

Over the past few years, Esseco USA has received a significant increase in the number of questionnaires, surveys, and document requests from our customers.

Most of these requests focus on the same product, manufacturing, quality, and safety issues.

Moving forward, we will be unable to complete each customer's specific documentation requests.

In order to respond to all of these varied types of requests, Esseco USA has generated a comprehensive product specific Data Package (Data Pack) that will provide most if not all of the requested information.

We are confident that this Data Pack will ensure that consistent information is provided in a timely and efficient manner. The Data Pack is updated annually to ensure all data is accurate, and additionally the Data Pack will be updated in reaction to major regulatory changes.

Sincerely

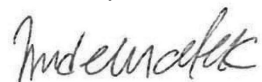

Esseco USA Technical Services

All statements, information, and data given herein are believed to be accurate and reliable but are presented without guaranty, warranty, or responsibility of any kind, express or implied. Statements or suggestions concerning possible use of our products are made without representation or warranty that any such use is free of patent infringement, and are not recommendations to infringe any patent. The user should not assume that all safety measures are indicated or that other measures may not be required. All suggestions made herein are intended for use by persons having requisite knowledge and skill, and are to be utilized at their own risk. Esseco USA assumes no responsibility for this information, and potential purchasers waive all claims they may have and agree to indemnify and hold harmless Esseco USA from any claims or damages they may later allege relative to their reliance upon these suggestions.

## General

### Product

Name	Ammonium Bicarbonate Food Grade
Code	1AJANE

### Supplier

Name	Esseco USA
Address	4 Gatehall Drive, Parsippany, NJ 07054
Phone	973-267-3330
Internet	<a href="https://www.essecousa.com/">https://www.essecousa.com/</a>

### Manufacturer

Name	Addcon Nordic AS
Address	Herøya Industrial Park B-85, Hydrovegen 55, 3936 Porsgrunn, Norway
Phone	+47 35 56 41 00
Internet	<a href="https://www.addcon.com/index.php/en/">https://www.addcon.com/index.php/en/</a>
Country of Origin	Norway

## Products Details

### Product References

- CAS No. (Chemical Abstracts Service): 1066-33-7
- EC No. (European Inventory of Existing Commercial Chemical Substances): 213-911-5
- E No. (EU number for additives): E503
- REACH (Registration, Evaluation, Authorization of Chemicals): registration number 01-2119486970-26

### Storage

- Store the product (in original packaging when possible) in a cool (below 85 F), well-ventilated, and dry indoor location.
- Shelf-life is 24 months from date of manufacture when stored in original container
- The characteristics of the product might cause the formation of agglomerates and lumps over time, typically from 12 months onward. The formation of agglomerates and lumps will not influence the active substances and the chemical characteristics of the product.

### Compliance

- Regulation (EU) No 231/2012 (food additives)
- Food Chemicals Codex(FCC) XII

### Packaging

- The packaging used for the Ammonium Bicarbonate sold by Esseco USA is suitable for food contact.
- The Ammonium Bicarbonate sold by Esseco USA is packaged on pallets that have been heat treated and made from European wood. No fungicides including 2,4,6 tribromophenol (TBP) or 2,4,6 trichlorophenol (TCP) are used on any pallets for this product.
- All the Ammonium Bicarbonate that is sold in 50 lb bags by Esseco USA has gone through a metal detection device when it was packaged.

### Residual

- The Ammonium Bicarbonate sold by Esseco USA does not contain any of the solvents listed in the United States Pharmacopeia general chapter <467> (Class 1, Class 2, Class 3, or other Table 4), the European Pharmacopeia, or the International Conference on Harmonization of Technical Requirements for Registration of Pharmaceuticals for Human Consumption (ICH) Residual Solvent (OVI) Lists. In addition, it does not contain any other organic solvents.

### Composition

<b>Component</b>	<b>Percent</b>	<b>CAS Number</b>
Ammonium Bicarbonate	99.4	1066-33-7
Magnesium Carbonate	0.6	546-93-0
Total:	100.0	

## Manufacturing

### Site Information

- Size of Site 200,500 sq ft
- Total Employees 57
- Production Staff 35
- Quality Unit Staff 2
- Quality Assurance Staff 2

### Process

- The Ammonium Bicarbonate food grade is manufactured using a synthetic process.
- This is a continuous process in a closed plant
- The raw materials of ammonia and carbon dioxide are reacted and then concentrated until the required density is reached.
- The crystalline product is separated by centrifuge and dried.
- The dried product is blended with the additive Magnesium Carbonate.
- The process is controlled by an automatic system with periodic testing and adjustments performed by the operators.
- The product is packaged in a closed line, equipped with a metal detector.

### Manufacturing Information

- The Ammonium Bicarbonate sold by Esseco USA has not been irradiated.
- The product is manufactured using current Good Manufacturing Practices (cGMP).

### Quality System

- The plant maintains a FSSC 22000 Certification which meets the Global Food Safety Initiative(GFSI).
- The plant maintains an ISO 9001:2015 Certification.
- The plant has an FDA registration number of 17179467870.

### Lot Numbering System

- Numbering System Explanation

The first two numbers designate the day of the month.  
The following three letter designate the calendar month.  
The last four numbers designates the year of production.

- Example for Lot Number 22.Jun.2022

22 – Day on month of Manufacture, 22  
Jun – Calendar month, June  
2022 - Product was packaged in 2022

## Products Not Used in Manufacturing of Product

This product does not contain and hasn't been in contact with the following:

- Melamine
- Pesticides
- Residual Solvents (US & Europe Pharmacopeia Listings)

## Food Information

### Food Information

- This product is a substance that is generally recognized as safe (GRAS) per Title 21 of the Code of Federal Regulations Part 184.1135 (2020).
- The product is in compliance with all Kosher requirements.
- The product is in compliance with all Halal requirements.
- The product does not contain any ingredients of animal origin or alcohol. Furthermore, we can exclude any risk of environmental contamination during manufacture, filling, packing, transportation and storage.
- The Food grade Ammonium Bicarbonate sold by Esseco USA meets all of the requirements of the US Food and Drug Administration (FDA) Food Safety Modernization Act (FSMA).
- Esseco USA is the importer of record for the Food grade Ammonium Bicarbonate sold by Esseco USA and has taken all of the necessary steps to be compliant with the United States Food and Drug Administration's Foreign Supplier Verification Program (FSVP) for importers of food for humans and animals.

### Diet Suitability

The product is suitable for:

- Vegans
- Lacto / Ovo-lacto vegetarians
- Diabetics
- Lactose intolerants
- Celiacs

### Microbiological

The Ammonium Bicarbonate sold by Esseco USA has been tested and does not contain microbiological hazards. Retesting is done on an annual basis.

### BSE/TSE/GMO/BE

This is to certify that Ammonium Bicarbonate sold by Esseco USA does not contain any materials that are of organic or animal origin. In addition, it does not come in contact with materials of organic or animal origin in its manufacture. Therefore, it is BSE / TSE compliant and contains no Genetically Modified Organisms (GMO's) or Bioengineered(BE) materials.

## Documents

### Reference Documents

- ISO 9001:2015 Quality Management System
- HACCP Chart
- Allergen Statement
- FSSC 22000 GFSI Certification
- Kosher Certificate
- Halal Certificate
- Nutrition Statement

### Other Documents

- Certified Food Grade Guarantee
- Organizational Chart
- Bioterrorism Statement
- 50 lb Package Label



## AMMONIUM BICARBONATE FOOD GRADE DATA PACKAGE REFERENCE DOCUMENTS

ISO 9001:2015 Quality Management System	Page 2
HACCP Chart	Page 3-4
Allergen Statement	Page 5
FSSC 22000 GFSI Certification	Page 6
Kosher Certificate	Page 7
Halal Certificate	Page 8
Nutrition Statement	Page 9

# MANAGEMENT SYSTEM CERTIFICATE

Certificate no.:  
167759-2014-AQ-DEN-DANAK

Initial certification date:  
15 December 2006

Valid:  
14 July 2024 – 13 July 2027

This is to certify that the management system of  
**ADDCON Nordic AS**  
Hydrovegen 55, Herøya Industripark B-85, 3936 Porsgrunn, Norway

has been found to conform to the Quality Management System standard:  
**ISO 9001:2015**

This certificate is valid for the following scope:

**Production, sales, distribution and marketing of organic acids, their salts and bases: Feed additive and premixtures for use in poultry's and pig's food. De-icing liquid used for de-icing runways/open areas. Ensiling agent for grass enables higher energy intake by ruminants. Preservation agent for fishmeal industry, fish byproducts and slaughter facilities on land. Production of Potassium formate (liquid and solid) as Drill-in and completion fluid for use within the oil and gas industry. Secondary refrigerant for use in indirect cooling system. Amoniumbicarbonate rising agent for use in food.**

Place and date:  
Hellerup, 02 July 2024



For the issuing office:  
DNV - Business Assurance  
Tuborg Parkvej 8, 2., 2900 Hellerup, Denmark



Jesper Schultz  
Management Representative

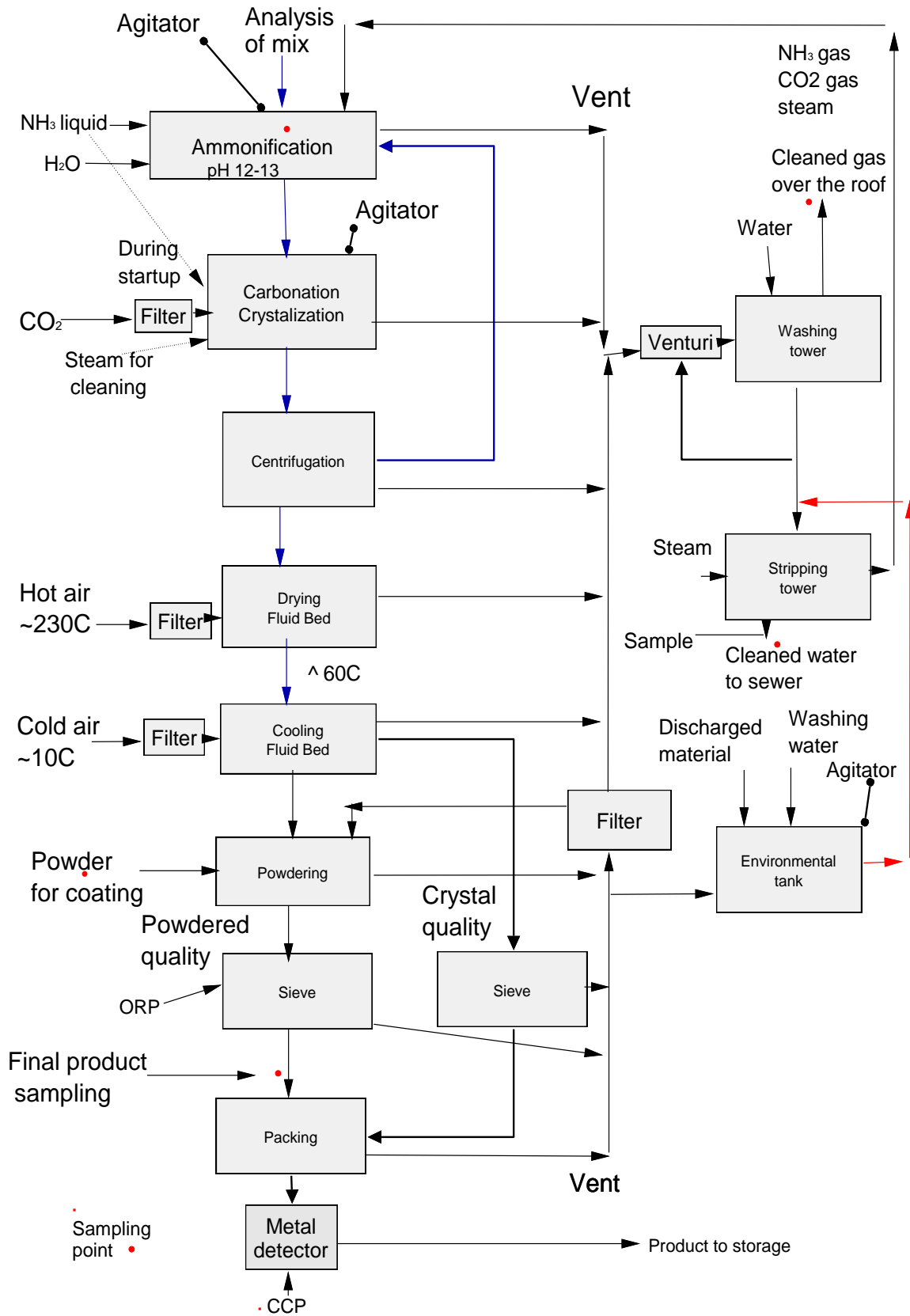

### TRANSPORT OF RAW MATERIAL

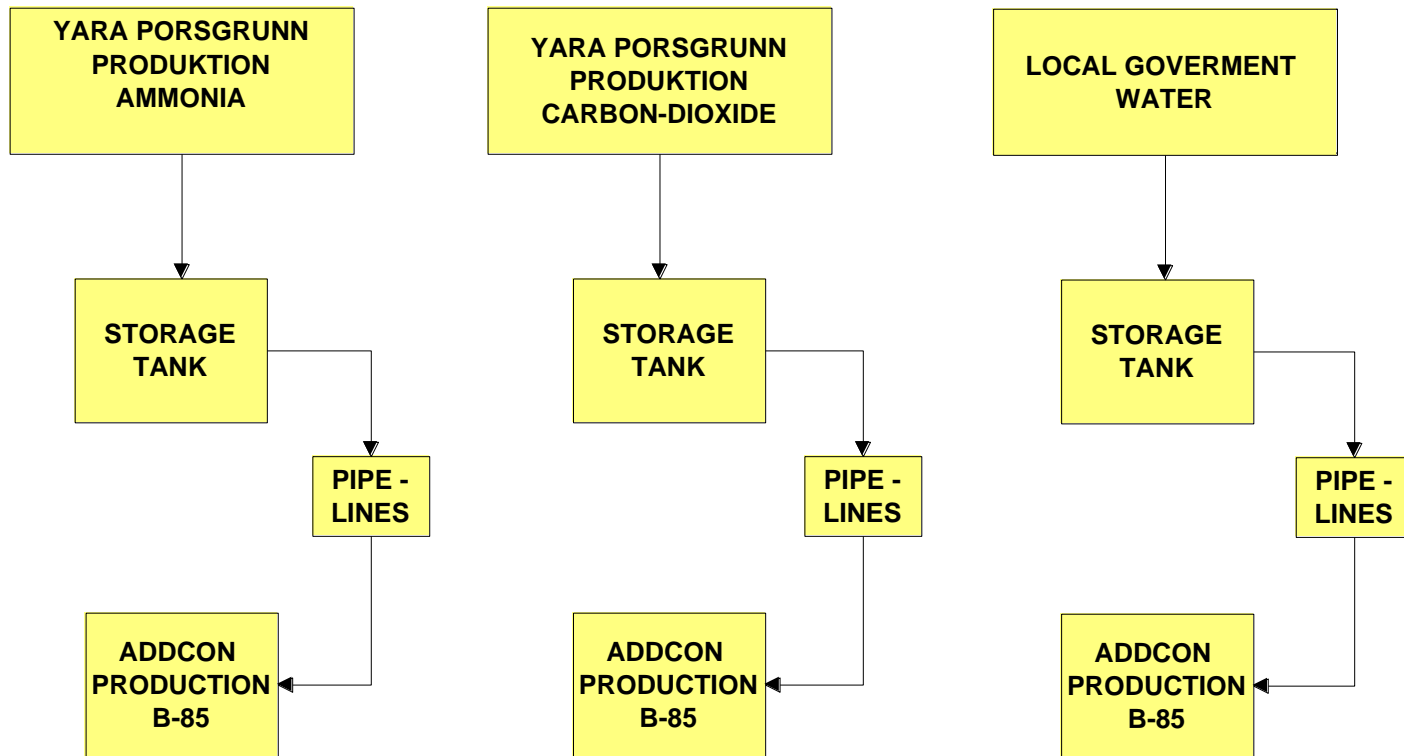

March 31, 2022

## Manufacturer ADDCON Nordic AS

### ALLERGENS STATEMENT

We can confirm that our Ammonium bicarbonate (ABC) is not produced with raw materials which are influenced by allergens and that we do not use allergenic materials in the engineering processes.

The list of allergens below is according to Directive 2000/13/WE as amended Directive 2003/89/EC, 2007/68/EC and 1169/2011/EC.

Our ammonium bicarbonate does not contain any of the following known allergens:

Artificial Sweeteners.

Celery and products thereof.

Colorants.

Crustaceans and products thereof

Dyes.

Egg or Egg Products.

Gluten (Wheat, Barley, Rye, or Oats) products thereof.

Other cereals containing gluten and products thereof (rye, barley, oat, spelt, kamut, rice and wild rice, sorghum, buckwheat, millet, quinoa).

Fish and products thereof.

Lactose.

Latex..

Lupin and products thereof

Molluscs and products thereof..

Milk or Milk Products (cow's milk proteins, lactose...).

Monosodium Glutamate (MSG)

Mustard and products thereof.

Peanuts or Peanut Products.

Preservatives.

Seafood or Seafood Products (Fish or Shellfish).

Seeds or Seed Products (Cotton, Poppy, Sesame, or Sunflower).

Soybeans or Soybean Products.

Nuts or Nut Products (Almond, Brazil, Cashew, Chestnut, Hazelnut, Pine, Pistachio, Pecan, Macadamia, or Walnut).

Wheat or Wheat Products.

Sulphur dioxide and sulphites are not contained in concentrations of more than 10mg/kg.



Øyvind O Due  
HSEQ Manager  
ADDCON Nordic AS

**Postal address:**

ADDCON Nordic AS  
P.O Box 1138  
3905 Porsgrunn  
Norway

**Visiting address:**

ADDCON Nordic AS  
Herøya Industrial Park B-85  
Hydrovegen 55  
3936 Porsgrunn  
Norway

**Production address:**

ADDCON Nordic AS  
Herøya Industrial park B-85  
Hydrovegen 55  
3936 Porsgrunn  
Norway

**Tlf No:**

+47 35 56 41 00

Registration No:  
NO 988 774 677 MVA



# MANAGEMENT SYSTEM CERTIFICATE

Certificate no.:  
C620347  
COID Code:  
NOR-1-2080-429522

Initial certification date:  
15 December 2006

Valid:  
03 July 2024 – 02 July 2027

This is to certify that the Food Safety Management System of  
**ADDCON Nordic AS**  
Hydrovegen 55, Herøya Industripark B-85, 3936 Porsgrunn, Norway

has been assessed and determined to comply with the requirements of  
**FSSC 22000**

Certification scheme for food safety management systems consisting of the following elements:  
ISO 22000:2018, ISO/TS 22002-1:2009 and Additional FSSC 22000 requirements (Version 6).

This certificate is applicable for the scope of:

**Production of ammonium bicarbonate as food ingredient. Category K**

Date of Certification Decision:  
**12 August 2024**

Date of the last unannounced audit:  
**29-30 June 2022**

Issue Date / Place and date:  
**Vimercate (MB), 13 August 2024**

DNV:



FSSC:



MS N°0003

Membro degli Accordi di Mutuo Riconoscimento EA, IAF  
e ILAC. Signatory of EA, IAF and ILAC Mutual  
Recognition Agreements

For the issuing office:  
**DNV Business Assurance Italy S.r.l.**  
Via Energy Park, 14, - 20871 Vimercate (MB) -  
Italy



**Sabrina Bianchini**  
Management Representative

January 9, 2026

כ' בטבת ה'תשפ"ו

KOSHER CERTIFICATE

אישור כשרות

I hereby certify that the **Ammonium Bicarbonate**, manufactured by **ADDCON Nordic AS in Porsgrunn, Norway**, is Kosher Parve also for **Passover**.

הריני מאשר כי האמוניום ביקרבונאט המיוצר ע"י חברת אדכון במפעל בפושגרון, נורבגיה, הינו כשר פרווה גם לפסח.

- This certificate is valid until January 20, 2027.

- תוקף תעודה זו:

י"ב בשבט ה'תשפ"ז

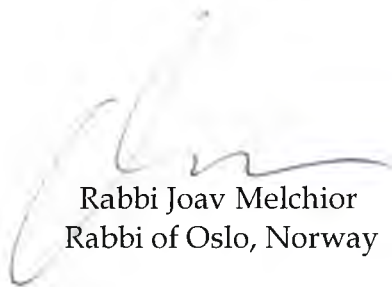
  
Rabbi Joav Melchior  
Rabbi of Oslo, Norway

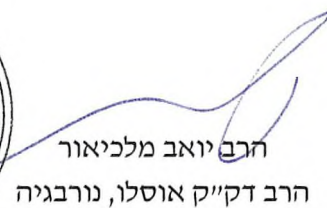

  
הרב יואב מלכיאור  
הרב דק"ק אוסלו, נורבגיה





المجلس الإسلامي في النرويج

# HALAL CERTIFICATE

**Certificate number:** IRN263468

**Valid until:** 31.12.2026

**The Islamic Council of Norway (IRN)** certifies that company:

**ADDCON Nordic AS**

Herøya Industripark, Bygg 85,  
Hydrovegen 55, 3936 Porsgrunn, Norway  
Organisation number: 988774677  
VAT no.: NO 988774677MVA

Has undergone audit for following production unit only:

**Herøya Industripark, Bygg 85, Hydrovegen 55, 3936 Porsgrunn, Norway**

The auditing includes inspections on all aspects of the operations, such as documentation, raw materials, processes, handling, tools, storage, cleanliness, packaging, and labeling.

The production unit has been certified for following products, which are produced in a *Sharia-compliant* facility and in accordance with *Sharia law* of halal and haram:

Pos.	Product name	Pos.	Product name
1	Ammonium bicarbonate	4	Ensilox N/L
2	Formi NDF	5	Aquaform
3	ADDCON XL 2.0		

**Date:** 18.12.2025

**Certificate issued by:** Islamic Council of Norway

Islamsk Råd Norge (IRN)

halal@irn.no

www.irn.no

A registered organization in Norway,  
org. no.: 982842840

**Signature:**

Masoom Zubair  
Chairman IRN



## NUTRITIONAL VALUE OF AMMONIUM BICARBONATE

Unit of Measurement, 100 Grams

Total Fat:	0 g
Saturated Fat:	0 g
Trans Fat:	0 g
Cholesterol:	0 mg
Sodium:	0 mg
Total Sugar:	0 g
Added Sugar:	0 g
Fiber, dietary:	0 g
Protein:	0 g
Total Carbohydrates:	0 g
Available Carbohydrates:	0 g
Ash:	0.55 g
Water:	0.25 g
Vitamin A:	0 µg
Vitamin C	0 µg
Vitamin D:	0 µg
Energy:	0 kcal
Calcium:	0 mg
Magnesium:	158 mg
Iron:	0 mg
Potassium:	0 mg

January 2, 2026

TECHNICAL SERVICE  
Phone: 973 267 3330  
Fax: 973 267 8299



AMMONIUM BICARBONATE FOOD GRADE DATA PACKAGE OTHER DOCUMENTS

Certified Food Grade Guarantee	Page 2
Organizational Chart	Page 3-4
Bioterrorism Statement	Page 5
50lb Package Label	Page 6



**GUARANTEE UNDER SECTION 303 (C) (2) OF THE  
FEDERAL FOOD, DRUG, AND COSMETIC ACT**

FOR THE PURPOSE OF SECTION 303(C) (2) OF THE FEDERAL FOOD AND COSMETIC ACT, WE HEREBY GUARANTEE THAT, AS OF THE DATE OF EACH SHIPMENT BY US TO YOU OF ANY ARTICLE LISTED BELOW SUCH ARTICLE IS NOT, WHEN SHIPPED, ADULTERATED OR MISBRANDED WITHIN THE MEANING OF THE FEDERAL FOOD, DRUG, AND COSMETIC ACT OR OF ANY APPLICABLE STATE LAW IN WHICH THE DEFINITIONS OF ADULTERATION AND MISBRANDING ARE THE SAME AS THOSE CONTAINED IN THE FEDERAL FOOD, DRUG, AND COSMETIC ACT. WE FURTHER GUARANTEE THAT, AS OF THE DATE OF EACH SHIPMENT, NO SUCH ARTICLE IS AN ARTICLE WHICH MAY NOT, UNDER THE PROVISIONS OF SECTION 404 OR 505 OF THE FEDERAL FOOD, DRUG, AND COSMETIC ACT, BE INTRODUCED INTO INTERSTATE COMMERCE.

THIS GUARANTEE SHALL NOT EXTEND TO COVER THE RESPONSIBILITIES OF A DISTRIBUTOR IN SITUATIONS WHERE THE ARTICLE IS TRANSFERRED IN BULK OR IS REPACKAGED. MOREOVER, THIS GUARANTEE SHALL BE VOID AND OF NO EFFECT IN ANY INSTANCE WHERE THE PARTICULAR USE BY YOU OF ANY ARTICLE TO WHICH THIS GUARANTEE WOULD OTHERWISE APPLY IS A USE WHICH IS NOT IN ACCORDANCE WITH THE REQUIREMENTS OF THE FEDERAL FOOD, DRUG, AND COSMETIC ACT OR APPLICABLE STATE LAWS.

THIS GUARANTEE SHALL BE A CONTINUING GUARANTEE AND SHALL CONTINUE IN EFFECT FOR A PERIOD OF FIVE YEARS FROM THE DATE HEREOF, OR UNTIL SUCH EARLIER DATE AS YOU SHALL RECEIVE FROM US WRITTEN NOTICE OF THE REVOCATION OF THE GUARANTEE CONTAINED HEREIN OR A CHANGE IN FEDERAL REGULATION OCCURS.

PRODUCT	GRADE	CODE
AMMONIUM BICARBONATE	FOOD GRADE	1AJANE

SIGNED: Mina Abdelmalek

TITLE: Sales Engineer

DATE: January 2, 2026

**QMS0201 - Organization chart**Dokumentadministrator: Martin Sneltved  
Godkjent av: Øyvind Oskarsen DueGyldig fra: 26.03.2024  
Revisjonsfrist: 26.03.2027Revisjon: 2.0  
ID: 1474

---

**ORGANIZATION CHART**

ID:				QMS0201	Document
Originator:	Øyvind Oskarsen Due	Revision Date:	March 26th, 2024		
Approver:	Per Ove Jakobsen	Revision:			22

**COTENTS:**

1. Management
2. ADDCON Nordic AS, Business Organization.
3. Porsgrunn Site Organization.
4. Porsgrunn Production.
5. R&D.
6. Marked segment.
7. EHS/ Quality.
8. Admin- Logistic.
9. Logistics department.

2. Porsgrunn Site Organization

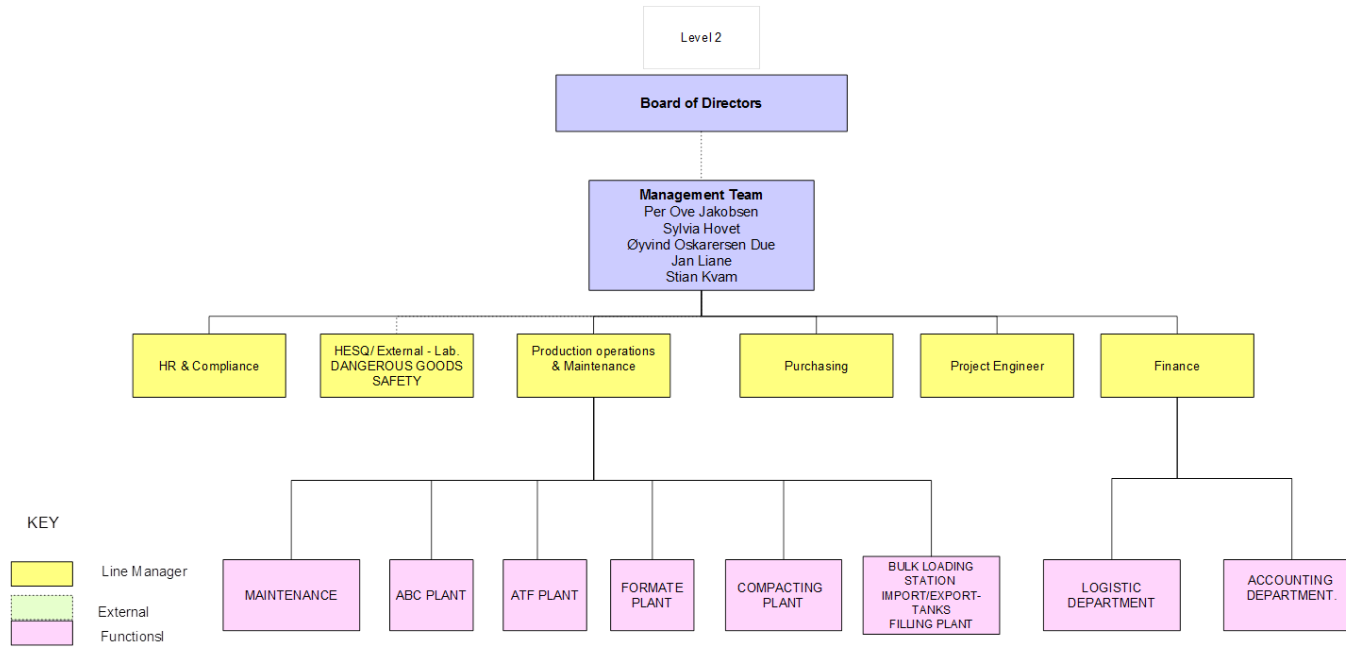

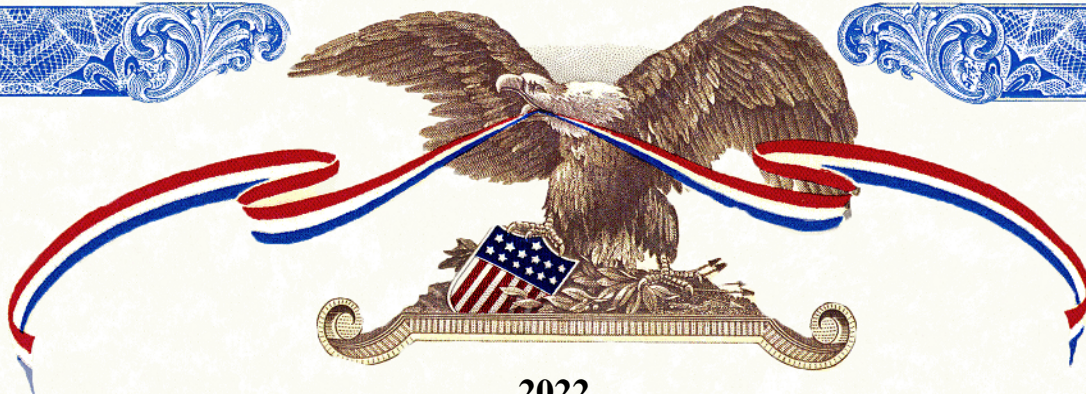

2022

## CERTIFICATE OF REGISTRATION

*This certifies that:*

**Addcon Nordic AS**  
**Heroya Industripark B-85, Hydrovegen 55**  
**Porsgrunn, Telemark N-3936**  
**Norway**

is registered with the U.S. Food and Drug Administration pursuant to the Federal Food Drug and Cosmetic Act, as amended by the Bioterrorism Act of 2002 and the FDA Food Safety Modernization Act, such registration having been verified as currently effective on the date hereof by Registrar Corp:

U.S. FDA Registration No.: **17179467870**  
U.S. Agent for FDA **Registrar Corp**  
Communications: 144 Research Drive, Hampton, Virginia, 23666, USA  
Telephone: +1-757-224-0177 • Fax: +1-757-224-0179

*This certificate affirms that the above stated facility is registered with the U.S. Food and Drug Administration pursuant to the Federal Food Drug and Cosmetic Act, as amended by the Bioterrorism Act of 2002 and the FDA Food Safety Modernization Act, such registration having been verified as effective by Registrar Corp as of the date hereof, and Registrar Corp will confirm that such registration remains effective upon request and presentation of this certificate until December 31, 2022, unless such registration has been terminated after issuance of this certificate. Registrar Corp makes no other representations or warranties, nor does this certificate make any representations or warranties to any person or entity other than the named certificate holder, for whose sole benefit it is issued. Registrar Corp assumes no liability to any person or entity in connection with the foregoing. The U.S. Food and Drug Administration does not issue a certificate of registration, nor does the U.S. Food and Drug Administration recognize a certificate of registration. Registrar Corp is not affiliated with the U.S. Food and Drug Administration.*

**Registrar Corp**  
144 Research Drive, Hampton, Virginia, 23666, USA  
Telephone: +1-757-224-0177 • Fax: +1-757-224-0179  
info@registrarcorp.com • www.registrarcorp.com

A handwritten signature in blue ink that reads "David Lennarz".  
**David Lennarz**  
**Executive Director**  
**Registrar Corp**

Dated: September 21, 2021

© Copyright 2003-2020 Registrar Corp

<b>Bischof+Klein</b>	
Kunde/Customer/Klient: Addcon Nordic AS	
Mat. Nr.:	4533 8976
ID-Nummer/ ID number / Numer wzoru:	4533 8976-1
Format/ Dimensions/ Wymiary:	360+90x660
Farben/ Colours/Kolory:	
1. <input checked="" type="checkbox"/> Black	5. <input type="checkbox"/>
2. <input checked="" type="checkbox"/> PANTONE 158 C	6. <input type="checkbox"/>
3. <input checked="" type="checkbox"/> PANTONE 485 C	7. <input type="checkbox"/>
4. <input checked="" type="checkbox"/> Stand	8. <input type="checkbox"/>
Farben BD unten: Colours bottom sheet: Kolory denko górne:	Farben BD oben: Colours top bottom sheet: Kolory denko dolne:
Kundenfreigabe/ Customer release/ Zatwierdzenie klienta: Die in der PDF dargestellten Farben sind nicht farbecht, da es sich um eine Bildschirmdarstellung handelt. The colors shown in the PDF are not binding, as they are only shown on a screen. Kolory w pliku PDF są niewiązace, ponieważ jest to tylko odwzorowanie na ekranie monitora.	
Datum: Date: Data:	07.08.2025

Übersetzung/Translation/tłumaczenie:	
<input type="checkbox"/> Lack/lacquer/Lakier	
<input type="checkbox"/> ohne Vorbehandlung/no pretreatment/ Brak aktywacji	
<input checked="" type="checkbox"/> Stand/stand/Siatka	

<input checked="" type="checkbox"/> 1) Abwärtsrichtung zum Kunden (Umwendung direction for customer/ Kierunek nawinięcia dla klienta)	<input type="checkbox"/> 2) Umwendung direction for converting department (Kierunek nawinięcia dla konfekcji)
<input type="checkbox"/> 3) Längsrichtig außen liegend (Largitudinal seam outside) (grzew wzdużny na zewnatrz)	<input type="checkbox"/> 4) Längsrichtig innen liegend (Largitudinal seam inside) (zgrzew wzdużny wewnatrz)
<input checked="" type="checkbox"/> 5) VS innen liegend (Frontside on inside) (grzd do wewnatrz)	<input type="checkbox"/> 6) VS außen liegend (Frontside on outside) (grzd na zewnatrz)
<input type="checkbox"/> 7) Druck von innen leibar (Print legible from inside) (nadruk czytelny z wewnatrz)	<input type="checkbox"/> 8) Druck von außen leibar (Print legible from outside) (nadruk czytelny z zewnatrz)

660 mm Sacklänge / bag length / Długość cięcia  
660 mm Zylinderumfang / Cylinder Circumference / Obwód cylindra

50 lbs AMMONIUM BICARBONATE FOOD GRADE FFQ  
ESSECO INDUSTRIAL



## AMMONIUM BICARBONATE

FOOD GRADE FFQ - WITH 0.9% max MgCO<sub>3</sub> - CODE 1AJANE-0050LB

CONTAINS AMMONIUM BICARBONATE CAS 1066-33-7/ WITH MAGNESIUM CARBONATE CAS 39409-82-0

### ATTENTION

STORE IN THE ORIGINAL CONTAINER IN A COOL, DRY, WELL-VENTILATED LOCATION THAT IS PROTECTED FROM MOISTURE. IN CASE OF AN EMERGENCY INVOLVING THIS PRODUCT IN THE USA OR CANADA CONTACT CHEMTREC 800-424-9300

BEFORE USING, READ THE SAFETY DATA SHEET FOR THIS CHEMICAL

FOR PROFESSIONAL USE ONLY

CONTENTS MADE IN NORWAY



**Warning**  
Harmful if swallowed. Wash hands thoroughly after handling. Do not eat, drink or smoke when using this product. IF SWALLOWED: call a doctor if you feel unwell. Rinse mouth. Dispose of contents and container in accordance with local, state, and federal regulations.

PIM016 (R2-0423)  
ESSECO USA LLC - 4 Gatehall Drive - Parsippany, NJ 07054 - Tel 973-267-3330

ESSECO INDUSTRIAL  
BICARBONATE D'AMMONIUM FOOD GRADE FFQ  
22.7 kg



## BICARBONATE D'AMMONIUM

FOOD GRADE FFQ - AVEC 0.9% max MgCO<sub>3</sub> - CODE 1AJANE-0050LB

CONTIENT BICARBONATE D'AMMONIUM CAS 1066-33-7/ AVEC CARBONATE DE MAGNESIUM CAS 39409-82-0

### AVERTISSEMENT

ENTREPOSER DANS LE RÉCIPIENT D'ORIGINE DANS UN ENDROIT FRAIS, SEC, BIEN VENTILÉ ET À L'ABRI DE L'HUMIDITÉ. POUR UNE URGENCE AUX ÉTATS-UNIS ET CANADA, APPELEZ CHEMTREC 800-424-9300

AVANT D'UTILISER, CONSULTER LA FICHE DE DONNÉES DE SÉCURITÉ

EXCLUSIVEMENT POUR USAGE PROFESSIONNEL

CONTENU FABRIQUÉ EN NORVÈGE



**Attention**  
Nocif en cas d'ingestion. Se laver les mains soigneusement après manipulation. Ne pas manger, boire ou fumer en manipulant ce produit. EN CAS D'INGESTION: Appeler un médecin en cas de malaise. Rincer la bouche. Éliminer le contenu et le récipient conformément à la réglementation locale, régionale et nationale.

PIM016 (R2-0423)  
ESSECO USA LLC - 4 Gatehall Drive - Parsippany, NJ 07054 - Tel 973-267-3330

45 mm Pród/Front 360 mm 45 mm 45 mm Tyl/Back 360 mm 45 mm